

Inlet filter, front side mounting, line switch 2-pole

Standard- or Medical-Filter



C20



70° C



Description

- Panel Mount:
Screw-on from front side
- 3 Functions:
Inlet Protection class I, Line switch 2-pole, Line filter in standard and medical version
- Quick connect terminals 6.3 x 0.8 mm
- Alternative: version without line filter [EC11](#)

Approvals

- VDE License Number: 40001522
- UL License Number: E72928

Characteristics

- All single elements are already wired
- Line switch non-illuminated
Illuminated version on request
- With EMC-shield
- Ideal for application with high transient loads
- Qualified for use in equipment according IEC/EN 60950

Other versions on request

- Line switch, illuminated
- Line switch with other rocker marking

References

[General Product Information](#)

Weblinks

[Approvals](#), [RoHS](#), [CHINA-RoHS](#), [e-Store](#), [SCHURTER-Stock-Check](#), [Distributor-Stock-Check](#)

Technical Data

Ratings IEC	12 - 16A @ Ta 40 °C / 250VAC; 50Hz	Appliance-Inlet /-Outlet	C20 acc. to IEC/EN 60320-1, UL 498, CSA C22.2 no. 42 (for cold condition) pin-temperature 70 °C, 16A, Protection class I
Ratings UL/CSA	12 - 20A @ Ta 40 °C / 125VAC; 60Hz	Line Switch	Rocker switch 2-pole, non-illuminated, acc. to IEC 61058-1 Technical details
Leakage Current	standard < 0.5 mA (250 V / 60 Hz) medical < 5 µA (250 V / 60 Hz)	Line Filter	Standard and Medical Version, IEC 60939, IEC 60601-1, UL 1283, UL 544, EN 133 200, CSA C22.2 no. 8 Technical details
Dielectric Strength	> 1.7 kVDC between L-N > 2.7 kVDC between L/N-PE Test voltage (2 sec)	MTBF	> 1'700'000h acc. to MIL-HB-217 F
Allowable Operation Temp.	-25 °C to 85 °C		
Climatic Category	25/085/21 acc. to IEC 60068-1		
Degree of Protection	from front side IP 40 acc. to IEC 60529		
Protection Class	Suitable for appliances with protection class I acc. to IEC 61140		
Terminal	Quick connect terminals 6.3 x 0.8 mm		
Panel Thickness s	Screw-on: max 8 mm Mounting screw torque max 0.5 Nm		
Material: Housing	Thermoplastic, black, UL 94V-0		

Dimensions

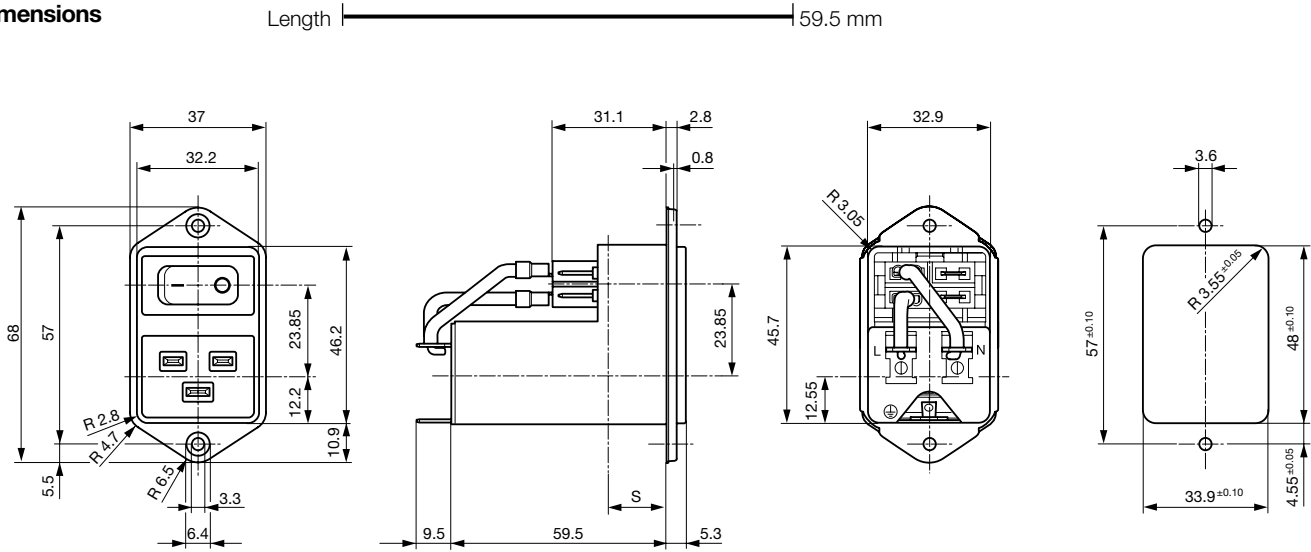

Technical Data of Filter-Components

Rated Current [A]	Filter-Type	internally wired	Inductances L [mH]	Capacitance CX [nF]	Capacitance CY [nF]	R [MΩ]
12	Standard Version	prewired	2 x 0.8	100	2.2	1
16	Standard Version	prewired	2 x 0.6	100	2.2	1
20	Standard Version	prewired	2 x 0.3	100	2.2	1
12	Medical Version (M5)	prewired	2 x 0.8	100	-	1
16	Medical Version (M5)	prewired	2 x 0.6	100	-	1
20	Medical Version (M5)	prewired	2 x 0.3	100	-	1

Diagrams

Standard version

Medical version (M5)

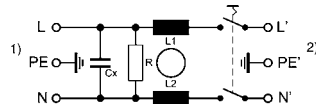
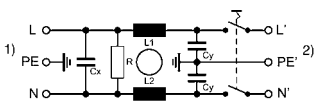

1) Line
2) Load

1) Line
2) Load

Attenuation Loss

Standard version

12 A

16 A

20 A

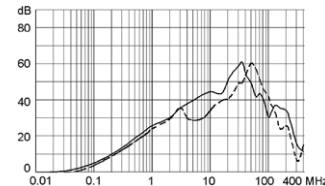
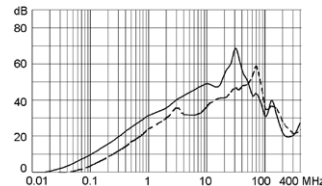
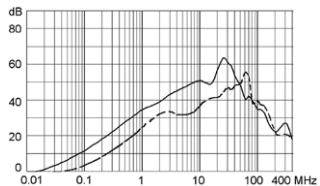

--- differential mode ____ common mode

Medical version (M5)

12 A

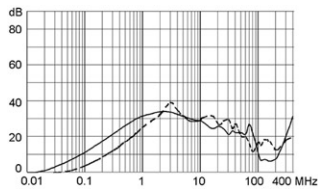

16 A

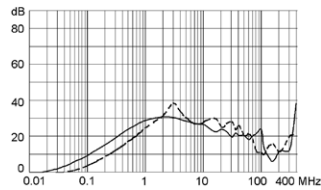

20 A

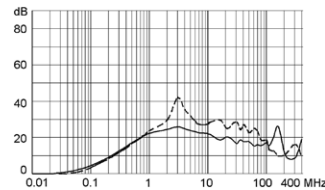

Variants

[Distributor-Stock-Check](#) | [SCHURTER-Stock-Check](#) | [e-Store](#)

Rated Current [A]	Filter-Type	internally wired	Line Switch	Order Number
12	Standard Version		2-pole	EC12.3101.001
16	Standard Version		2-pole	EC12.2101.001
20	Standard Version		2-pole	EC12.1101.001
12	Standard Version		2-pole	EC12.3101.002
16	Standard Version		2-pole	EC12.2101.002
20	Standard Version		2-pole	EC12.1101.002
12	Medical Version (M5)		2-pole	EC12.3201.001
16	Medical Version (M5)		2-pole	EC12.2201.001
20	Medical Version (M5)		2-pole	EC12.1201.001
12	Medical Version (M5)		2-pole	EC12.3201.002
16	Medical Version (M5)		2-pole	EC12.2201.002
20	Medical Version (M5)		2-pole	EC12.1201.002

Packaging unit 20 Pcs

Accessory

Description



[Assorted Covers](#)
Rear Cover

0859.0076

0859.0108



[Cord retaining kits](#)
Cord retaining strain relieve

Flat head, Z

0888.0021

Flat head, H

4700.0008